

# ELECTROPLATING DRYING TIME MINIMIZATION THROUGH BOLT DRYER MACHINE

Antonius Galang D.K<sup>1)</sup>, Arya Sena Wikantayasa<sup>1)</sup>, Johannes Christian Bagaskara<sup>1)</sup>,  
Shanti Kumbarasari<sup>1)\*</sup>, Yohanes T. Wibowo<sup>2)</sup>

<sup>1)</sup> Mesin Industri, Politeknik Industri ATMI, Indonesia

JL. Kampus Hijau No.3-Jababeka Education Park, Cikarang Baru- Bekasi 17520

<sup>2)</sup> Teknik Mesin dan Industri, Politeknik Astra, Indonesia

JL. Gaharu Blok F3 No. 1 – Lippo Cikarang, Cikarang Selatan- Bekasi 17530

\*Corresponding email: [shanti\\_kumbarasari@polinatmi.ac.id](mailto:shanti_kumbarasari@polinatmi.ac.id)

## ARTICLE INFORMATION

Revised  
20/09/2022

Accepted  
31/10/2022

Online-Published  
03/11/2022

©2022 The Authors. Published by  
AUSTENIT (Indexed in SINTA)

doi:  
[10.53893/austenit.v14i2.5445](https://doi.org/10.53893/austenit.v14i2.5445)

## ABSTRACT

One of the steps after the electroplating/coating process on the product is the drying process. In Micro, Small and Medium Enterprises, the drying process on CIV KG 0741 bolts with a diameter of 10 mm and a length of 20 mm requires a drying time of 6 hours. Drying simply and naturally has limitations, requiring a large drying area depending on the weather, time and temperature, which cannot be controlled. A simple automatic dryer is needed using a single-phase electric power source and simple and ergonomic maintenance methods to obtain a quality product with a measurable drying duration. Design and analysis of drying on the dryer. The dryer with dimensions of 680 x 480 x 967.12 mm<sup>3</sup> has a mass of 21.94 kg with a drum capacity of 20 kg. The motor propulsion used is 1 HP, 5.08 Nm of torque and capable of rotating at 1500 rpm with an effort of 39296.66 Joules. The dryer can dry as much as 20 kg of bolts in 5 minutes faster than solar energy, with a drying time of 15 minutes to 1 hour.

**Keywords** : bolt, automatic dryer, time efficiency, measureable time

## 1. INTRODUCTION

Quality is one of the fundamental and essential factors in the production process, which connects the voice of business and the customer (Schoenfeldt TI, 2008). Quality connects the voice of business with the voice of the customer. Those are components of product manufacturing and services (Manalo RG, Manalo MV, 2010). One method used to improve the performance and quality of metal products is electroplating or electro-deposition (Sungkowo et. al, 2021). Electroplating is a process of deposition or deposition of protective metal on metal by using an electric current in an electrolyte solution to produce new properties in the product as expected (Lee et al., 2020). After the electroplating process, the product is dried. On the scale of Micro, Small and Medium Enterprises, the drying process of electroplating products still uses sunlight. Drying using sunlight has disadvantages, namely relying on the weather and not getting a consistent and measurable drying time (Muin A, 2017), requiring a large area and non-uniform product performance (Yuliati et al., 2018).

Those uncertainties will lead to other uncertainty, including in quality achievement, such called defective goods. The presence of fingerprints left on the coating that has not dried is a form of a defective product or minor fault, as described in Figure 1.



**Figure 1.** The Defective Product

Using natural drying, as informed in past data, the drying process for CIVKG 0741 bolt material with dimensions of length 20 mm and diameter 10 mm and 5-10 minutes of electroplating process with zinc electronic solution require 6 hours of drying time. CIVYHB0814 bolt drying with a length of 16 mm and a diameter of 8 mm, immersion time of 5-10 minutes with the type of Zinc solution takes 8 hours. Considering the

various process time with uncertain times that will lead to a wide range of lower quality, a drying machine to make the necessary allocation of drying process time with an efficient and effective result is needed. In this paper, the drying problem and the required solution are formulated and worked on. The consideration of this study is to carry out the innovation with an economic aspect to be able to be used by Micro, Small and Medium Enterprises.

## 2. MATERIALS AND METHODS

Electroplating is the process of the surface coating of a product using a different type of product material to obtain certain benefits according to needs. The intention of this process is based on various purposes ranging from household to industrial purposes. Therefore, there are many materials for electroplating. The electroplating process in this study used a coating of Tin liquid, Zinc liquid and Silver liquid.

Tin plating is a coating process using tin liquid. The purpose of the coating is to make the object look better and to increase the product's durability due to the layer making the coated object safe against corrosion. For the function, it is very efficient to protect objects.

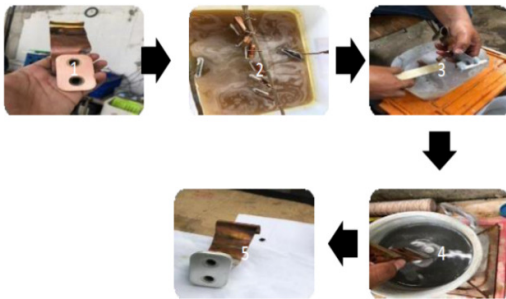

**Figure 2.** Tin Coating

Figure 2 describes the steps of Tin coating in detail. The first small picture is the initial uncoated product. The coating process was carried out by sinking the products into Tin liquid for 15 minutes. When the time is up, the coated product is rinsed using soap water. In the final step, the coated product was sunk again in hot water to make it dry faster.

Zinc plating is a coating process using liquid zinc. The purpose of the coating is to make it look better and increase the durability of an object because it can prevent rust. It serves as an electron absorber from the coated metal to prevent oxidation.

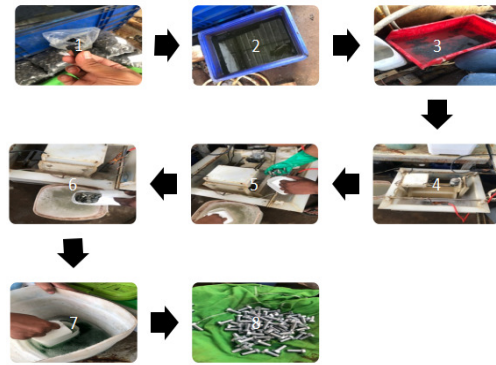

**Figure 3.** Zinc Plating

Figure 3 described of Zinc plating process in detail. Zinc plating begins with threshing the rust attached to the bolt using HCl liquid. While needed, the operators may take the brushing process. Then the bolt is put into the Zinc liquid for 45 minutes and stirred. After the time was up, the operators lifted the products for rinsing. Next, the blue color was given for 10 seconds and ended with the rinse process using hot water.

Silver plating is a coating process using a silver liquid which aims to make the object look better and prolong its life because this coating can make the coated object free from corrosion. The primary function of this coating is to prevent rust.

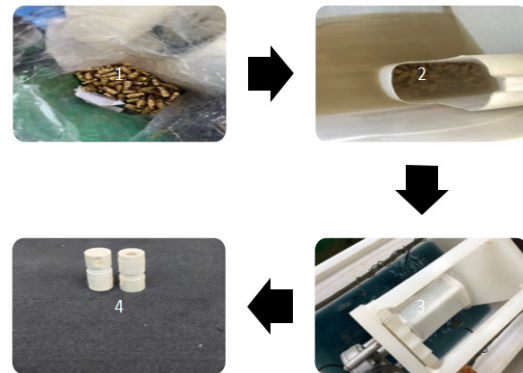

**Figure 4.** Silver Plating

The silver plating process is carried out by inserting the object into the cleaning liquid. Then it is put into a barrel with the silver liquid inside and mixed up for 45 minutes. Then the work piece will be rinsed with warm water and re dried again, as described in Figure 4.

To clarify, besides knowing the defective product, the operators must also know the excellent product. No fingerprints left; still wet product or other minor faults are not allowable. In this electroplating process, all products should dry perfectly without any compromise, as described in Figure 5.



Figure 5. Good Products

To clarify the design need's objective and avoid dispute, Table 1 describes the list of criteria that should be fulfilled in this design. The list below is used to guide the solution and answer the customer's needs.

Table 1. Design Criteria's

No	Criteria's	Demand/Wish
1	Work well	Demand
2	Load capacity 20kg	Demand
3	Drum diameter Ø450mm and height 500mm	Demand
4	Power source 1 phase	Wish
5	Easy to maintenance	Demand
6	Portable	Wish
7	Drying Time 5 minutes	Demand

3. RESULTS AND DISCUSSION

3.1 Research Results

The design and simulation of a dryer using Solidworks 2020 software determined measurable drying time and product performance as needed. Using a drying machine on the MSME scale means that the power source used is 1 phase, has a capacity of 20 kg and is easy to move. Based on mechanical calculations, the motor power used is 1,672 kW with a motor rotation of 1500 rpm. A Single phased line was chosen due to consideration of the ease of use, availability, and also performance. Figure 6 depicts the model of the drying machine in a 3D picture to be chosen as a design. To build this study will be broken down the 3D view in detail. Figure 7 depicts the design of podrum frame, bed and box dryer with a mass of 20.92 kg and dimensions of 680 x 480 x 967.12 mm

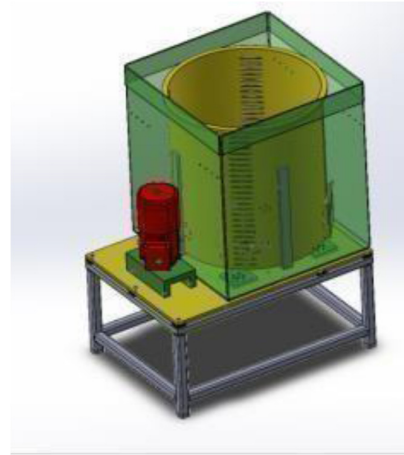

Figure 6. Drying Machine

The design specifications of the drying machine are the bolt dryer drum uses PVC, which is light and strong by using a pulley and v belt transmission. The belt circumference is 9.581 m/s, and belt rotation has 1.04 revolutions/unit length.

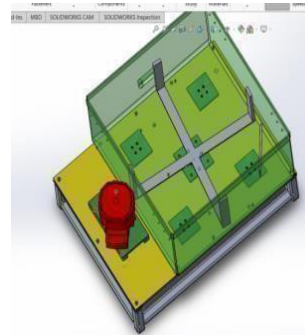

Figure 7. Design of Podrum Frame, Bed and Box Dryer

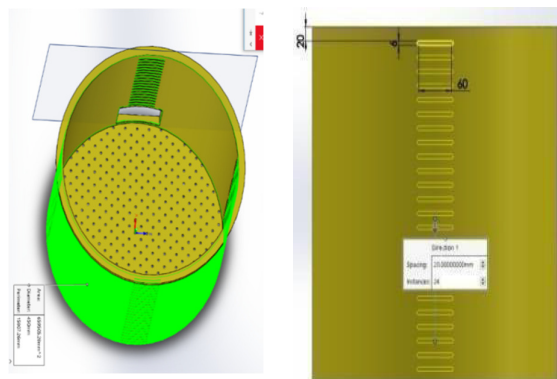

Figure 8. Replace Drum

In the design criteria, the dimension of the drum diameter is Ø450mm with a height of 500mm. Based on the requirements, the design created in this study is listed in Table 1. The selected material for this dryer is Poly Vinyl Chloride (PVC) with a weight of 2.2 Kg. Of course, this weight is to comply with design criteria.

The electric current flowing in the motor drive is 4.75 Ampere, and the blower drive is 0.11 Ampere, so the total electric current is 4.86 Ampere. The safety number is 1.25 then the current capacity that flows in the MCB is 10 Ampere. The electric design system shows that when turning on the MCB switch, press the feeding machine switch with the green indicator on. Then the dryer is ready to use. The detail of the wiring diagram is depicted in Figure 9.

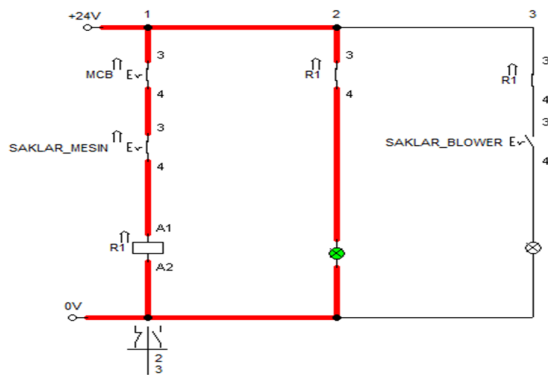

Figure 9. Drying Machine Wiring System

The yellow light indicator lights up after the MCB switch and blower switch are pressed to the on position to indicate the drying system is ready for use. Further and detail information in wiring diagram of machine indicator depicted In Figure 10.

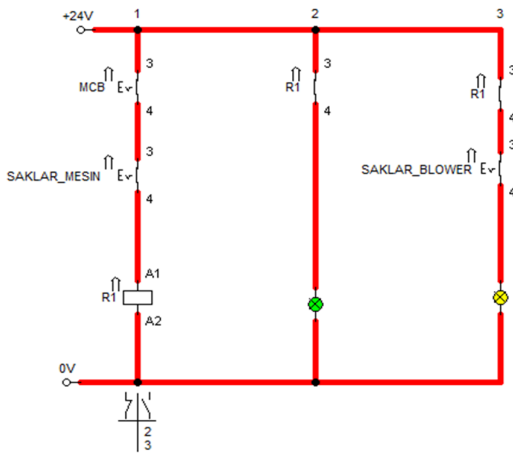

Figure 10. Machine Indicator of Drying System

One of the forms of automatic dryer that can be used for dyeing products is a rotary dryer. The shape of a cylindrical rotary dryer is a cylinder/drum with a movement that rotates the product inside to dry evenly. (R. Amyot, J.R et al., 1994) found the cylindrical drum material used in wastewater treatment at a temperature of 1100 C is stainless steel, with maximum stress lower than steel. A rotary dryer drum made of stainless steel

has a better temperature (Sundari et al., 2020) and stress distribution (Chandra et al., 2021) than steel (Hendra et al., 2019). The drying drum for bolt products from the electroplating process using PVC because the drum can be found on the market, is practical, lightweight, and resistant to alkalis and corrosion (Pham Le et al., 2021). The use of gears using low-alloy cast steel as a power source and the rotation of the drying machine is exhausted, resulting in cracks in the gears due to the stress intensity factor (Saracoglu et al., 2016). Hence, the electroplating product drying machine uses pulleys for rotation and power transmission. It is because easy to install and maintain and has high transmission speed. Besides, this is also obtained from the percentage increase in drying that is directly proportional to the ratio of the motor and pulley diameter, the mass flow rate of cooling water, and energy efficiency decreases. (Muhammad et al., 2021)

### 3.2 Discussion

After doing some mechanical calculations and designing electrically, the next step is a mechanical simulation of the design of the dryer. The mechanical simulation of the loading on the frame in Figure 11 shows that the frame is given a load of engine parts/components and products.

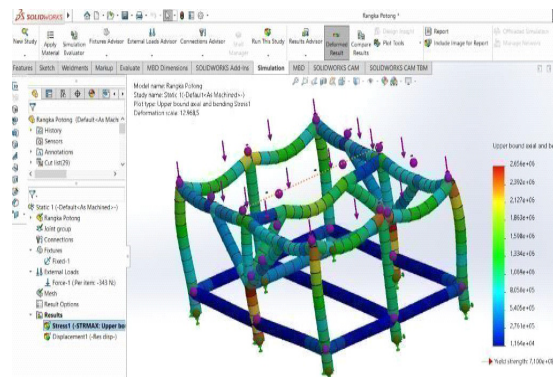

Figure 11. Mechanical Simulation on the Frame

The load on the support is the weight of the bed, drum, box, motor, and parts on the frame, and the product load is 20 kg. If added together, the engine frame supports a total load of 353.16 Newton's. After being simulated with the Solid Work 2020 software, Figure 11 shows a yield strength of  $7,100 \times 10^8$  Newton. Based on this iteration, the frame construction is declared safe.

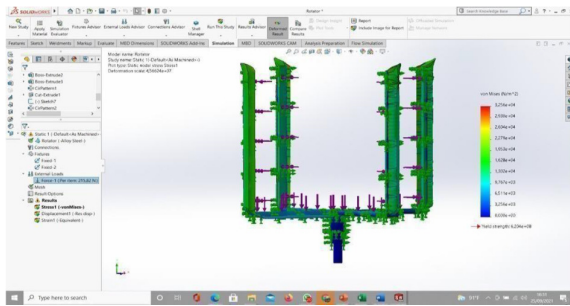

Figure 12. Drum Mechanical Simulation

After the mechanical design is simulated with a load of 20 kg, as shown in Figure 12, the construction shows a yield strength of  $6.204 \times 10^8$  Newton. To verify the safety of the design, the color coding in the mechanical simulation will inform us which part is safe and vice versa.

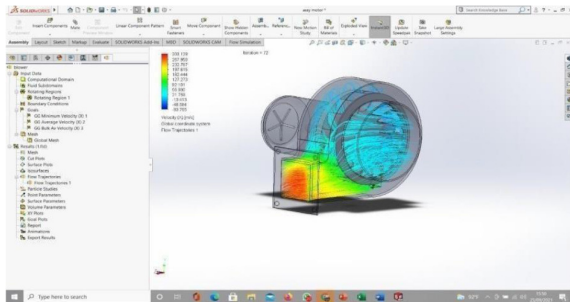

Figure 13. Blower Mechanical Simulation

As air pressure and airflow are the heart of the dryer, it is strange thing when this part was skipped and not discussed in this chapter. Figure 13 shows a simulated air pressure flow in a blower. Based on the calculation of the electric current used by the blower 0.11 Ampere with the blower power used 25 Watts. The flow of air pressure inside the blower is 90 - 105 Pa. Based on the simulation and calculations that have been done, 1 HP motor power with a torque of 5.08 Nm, and 1500 rpm motor rotation, the resulting effort is 39296.66 Joules with a bolt drying capacity of 20 kg in 5 minutes.

The design criteria, customer demands, and wishes were grabbed clearly and then used as a voice of the customer ought to be fulfilled through this design. Observing the electrical wiring system, this design confirms taking safe and proper action. At the end of the study, some critical simulations, such as mechanical and airflow simulations, were conducted to verify the previous steps had been performed and produced the real right things.

#### 4. CONCLUSION

Then it will be reviewed to ensure the level of originality. The design of the dryer with a capacity of 20 kg, dimensions of 680x 480 x 967.12 mm<sup>3</sup> with a mass of 21.93 kg, can be

driven by a motor of 1 HP, a torque of 5.08 Nm, and rotation of 1500 rpm. This drying machine is able to make 20 kg of the bolt a quality dry for 5 minutes. Undoubtedly faster than drying time with a natural process that takes about 15-60 minutes. This solution is able to answer the problem and provide a better and more proper solution. This machine has better efficiency ranging from 8-33%. For further research, future research can use automatic control for drying machines on electroplating products as the next step of research.

#### REFERENCES

- Schoenfeldt TI. (2008). *A Practical Application of Supply Chain Management Principles*. ASQ Quality Press.  
[https://www.goodreads.com/book/show/880172\\_5-a-practical-application-of-supply-chain-management-principles](https://www.goodreads.com/book/show/880172_5-a-practical-application-of-supply-chain-management-principles)
- Manalo RG, Manalo MV. (2010). Quality, Cost and Delivery performance indicators and Activity-Based Costing. In: 2010 IEEE International Conference on Management of Innovation & Technology [Internet]. Singapore, Singapore: IEEE; p. 869–74.  
<https://doi.org/10.1109/ICMIT.2010.5492805>
- Sungkowo, A., Trikolos, T., Al Hakim, R. R., Riyadi, S., Arief, Y. Z., & Jaenul, A. (2021). Material Test Comparison of Pure Aluminum (Al) and Pure Aluminum-Coated (Al) with Silver (Ag) Substrat Using Electroplating Method. *Electro Luceat*, 7(2), 179-187.  
<http://dx.doi.org/10.32531/jelekn.v7i2.381>
- Lee, J., Kim, H. G., Lee, J. H., Cho, S. H., Jung, K. W., Lee, S. Y., & Choi, J. W. (2020). Performance Differences Of Hexavalent Chromium Adsorbents Caused By Graphene Oxide Drying Process. *Scientific Reports*, 10(1), 1-8.  
<https://doi.org/10.1038/s41598-020-61760-2>
- Yuliati, S. (2018). Unjuk Kerja Rotary Dryer Pada Proses Pengeringan Biji Kopi. *Kinetika*, 9(3), 38-42.  
<https://jurnal.polsri.ac.id/index.php/kimia/article/view/2310/1093>
- R. Amyot, J.R.; Gowing, J.D.; Wylie, R.H.; Henzell. (1994). Configurability In A Diagnostic Expert System For Paper Machine Dryer Sections. *Nrc Publ. Arch. Arch. Des Publ. Du Cnrc*, No. 1, 1994, [Online]. Available: <https://NrcPublications.Canada.Ca/Eng/View/Object/?Id=B8e56d7d-Ea9e-42f8-Be66-Cf9b6fb18ac6>.
- Chandra, H., Putra, D. P., & Romli, R. (2021). Investigation of Stress on Multi-Level Shaft using Finite element Method Based on Computer-Aided Engineering. *Austenit*, 13(1), 23–27.  
<https://doi.org/10.5281/zenodo.4747728>

- Hendra, Syukriah, M. Silalahi, A. Indriani, Hernadewita, And Hermiyetti. Finite Element Method Analysis For Manufacturing Design Drum Dryer Of Rotary Dryer Machine. IOP Conf. Ser. Mater. Sci. Eng., Vol. 505, No. 1, 2019.  
<https://iopscience.iop.org/article/10.1088/1757-899X/505/1/012133>
- Pham Le, Q., Uspenskaya, M. V., Olekhovich, R. O., & Baranov, M. A. (2021). The Mechanical Properties Of Pvc Nanofiber Mats Obtained By Electrospinning. *Fibers*, 9(1), 2.  
<https://doi.org/10.3390/fib9010002>
- Saracoglu, G., & Yapici, A. (2016). Fatigue Analysis Of Girth Gear Of A Rotary Dryer. *Engineering Failure Analysis*, 68, 187-196.  
<https://doi.org/10.1016/j.engfailanal.2016.05.024>
- Muhammad, M., Yuniarti, E., Sofiah, S., Saputra, A., & Pani, A. (2021). Performa Motor Induksi Satu Phasa Sebagai Penggerak Mesin Pengering. *Jurnal Tekno*, 18(2), 1-10.  
<https://doi.org/10.33557/jtekn.v18i2.1469>
- Sundari, E., Taufikurrahman, T., & Syaputra, M. B. (2020). Pengaruh Variasi Temperatur Pemanasan terhadap Kekerasan dan Ketebalan Lapisan pada Chromizing Baja ST 37. *Austenit*, 11(2), 54–58.  
<https://doi.org/10.5281/zenodo.4547813>
- Muin, A. (2017). Peningkatan Kinerja Kompur Surya Tipe Kotak dengan Penambahan Cermin Reflektor. *Austenit*, 9(2).  
<https://doi.org/10.5281/zenodo.4547625>